

ROTARY TILLERS



CONTENT

Section 1: INSTRUCTION	PAGE 1
Section 2: SAFETY REGULATIONS	PAGE 4
Section 3: HANDLING AND TRANSPORTATION	PAGE 7
Section 4: INSTRUCTIONS OF USE	PAGE 8
Section 5: MAINTENANCE	PAGE 12

SECTION 1:

INTRODUCTION

This manual contains all the information and indications considered necessary to know, correctly use and normally service of **TL Series** (also called **machine** in the text) manufactured **AGRI** (also called **Manufacturer** in the text). The information and indications do not give a full description of the various components or a detailed illustration of how they operate, however, the user will find everything he normally requires in order to safely use the machine and keep it in a serviceable condition. Failure to comply with the indications given in this manual, negligence during work, incorrect use and unauthorized modifications of the machine may void the warranty supplied by the Manufacturer.

The Manufacturer therefore declines all and every liability for damage due to negligence and failure to comply with the instructions in this manual.

If repairs or overhauls of a complex nature are required, contact an authorized assistance center or distributors with specialized personnel who is at your complete disposal for prompt and accurate technical assistance and anything else that can ensure you get the best and most efficient performance from the machine.

This manual must be kept in a safe place, ready to hand for consultation throughout the entire life of the machine. Reference will solely be made to the Spanish version of the instructions in case of disputes. Some of the illustrations in the manual may not exactly depict the machine in your possession: they are included for the sole purpose of explaining the operations that must be carried out.

DESCRIPTION OF THE MACHINE

TL Series, bears «CE» marking in compliance with the European Union standards described in directive 2006/42/EC and successive modifications, as stated in the declaration of conformity with which each machine is equipped.

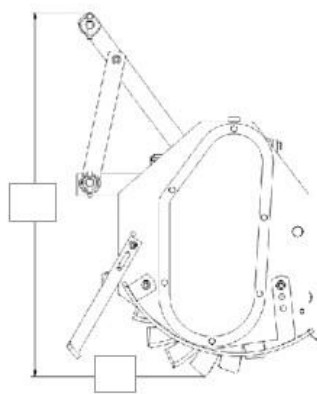
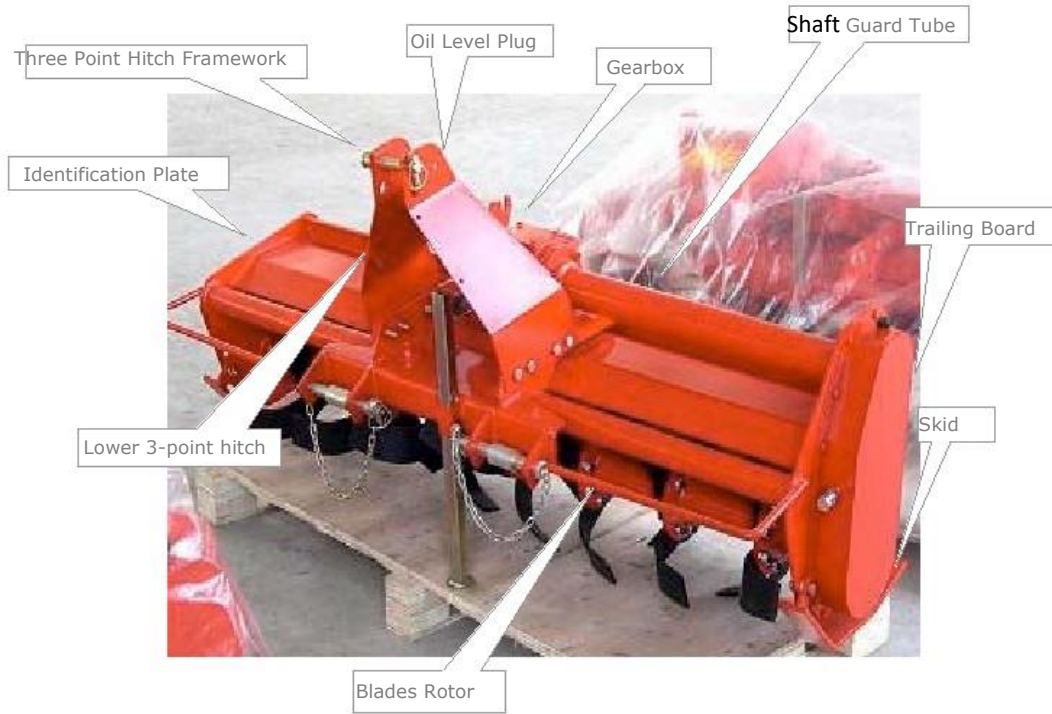

H

L

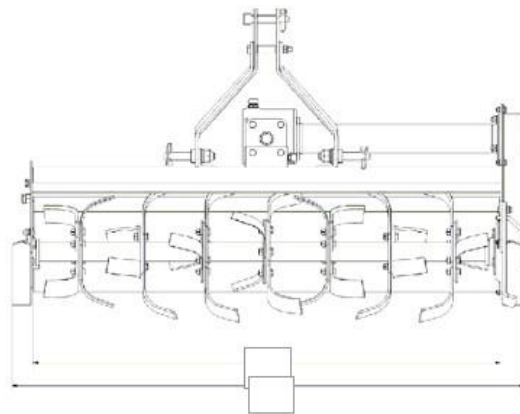

A

B

Working width	A	1045 mm1245mm	1395mm
Total width during transport	B	800mm800mm	800mm
Total Height	H	700mm700mm	700mm
Total Length	L	1250mm1450mm	1600mm
Weight (kg)		180190	200
Max. Power Tractor Kw/CV (540 RPM)		18-22 HP22-28 HP	25-30 HP
Hitch Category		Cat I	
Transmission		Maintenance 250H or yearly	
Shaft Security Type		540 RPM / Shear Bolt	
Speed Gearbox Type		AL 1 speed	
Gearbox Lubricant			
Lateral Transmission Type		SAE 140 1.5 Liters	
Working Depth		Internal Tightener / Chain 800g grease	
Blade Quantity		100 – 120 mm	
Trailing board type		2028	32
		with springs	

DESCRIPTION

The TL Series consists of a central framework with three-point hitch that is attached to armor. The machine only operates when hitched to a tractor with an adequate power rating (see technical specifications for the specific power).

The power required to operate the machine is transmitted by the tractor through the driveline (with CE marking) which engages with the central transmission unit (see exploded view of torque tube set) and operates the various tine rotors.

USE

The TL Series is solely designed for use in agriculture in order to prepare, work and break up the soil. One single person seated in the driver's seat of the tractor is able to carry out all the various operations. Any other use of the machine differing from the explanations given in this manual relieves for Manufacturer from all and every liability for deriving damage to persons, animals or property.

DENTIFICATION

Each machine is provided with an identification plate (14 Fig. 1) with the following data:

«CE» marking Serial number
 Manufacturer's name and address Weight (in kg)
 Machine model Year of manufacture

The data on the identification plate of the machine should be copied into the last page of this manual and must always be stated when spare parts and/or assistance are required.

Standard machine supply includes:

Driveline

Operation and maintenance manual for the machine
 «CE» declaration of conformity
 Exploded view for machine spare parts

NOISE LEVEL

The noise level (overhead noise) has been measured in compliance with the current laws, with the following results:

Sound pressure LpAm (A):

Acoustic power LwA (A):

The operator is advised to wear adequate anti-noise headphones as personal protective equipment to prevent damage to his hearing during daily work with the machine.

GENERAL SAFETY REGULATIONS

SECTION 2: SAFETY NOTES

The user must inform his personnel about the risks deriving from accidents, about the safety devices installed to safeguard the operator, and about the general accident-preventing regulations established by the Directives and by the laws in force in the country where the machine is used.

It is therefore essential for operator to carefully read this manual, particularly the safety notes, and to pay great attention to operations which could be particularly hazardous.

The Manufacturer declines all and every liability for failure to comply with the safety and prevention regulations given in this manual. Pay attention to this symbol when it appears in the manual. It indicates a possible danger situation. All the safety notes given below should be followed closely.

THREE DANGER LEVELS:

DANGER: This is the maximum level danger signal and warns that, unless the described operations are carried out correctly, they will cause serious injuries, death or long term health hazards.

WARNING: This warns that, unless the described operations are carried out correctly, they could cause serious injuries, death or long term health hazards

CAUTION: This sign warns that, unless the described operations are carried out correctly, they could cause damage to the machine and/or persons.

Warnings included in this manual are referred exclusively to the allowed and reasonably foreseeable uses. The guidelines presented below should be integrated with the wisdom and experience of those who work, elements that are essential to prevent misfortune.

The machine must be used by only one operator. Do not allow minors to use the machine. All the instructions given below should be followed closely. All changes to the machine that has not been previously authorized by the manufacturer (in writing), exclude its liability. Carefully verify the machine before every use.

The user must inform his personnel about the risks deriving from accidents, about the safety devices installed to safeguard the operator, and about the general accident-preventing regulations established by the Directives and by the laws in force in the country where the machine is used. It is therefore essential for operator to carefully read this manual, particularly the safety notes, and to pay great attention to operations which could be particularly hazardous.

The Manufacturer declines all and every liability for failure to comply with the safety and prevention regulations given in this manual. Pay attention to this symbol when it appears in the manual. It indicates a possible danger situation. All the safety notes given below should be followed closely.

SAFETY DECALS

The machine has been designed and built in compliance with all possible safety standards able to safeguard those who work with it. Despite this, there may still be residue hazards, which are signalled on the machine by decals. These decals (pictograms) are affixed to the machine and indicate the various situations of insecurity and danger in a brief form.

Keep the decals clean and immediately replace them if they detach or become damaged. Carefully read the following descriptions and memorize the meanings of the safety decals.



Before starting work, carefully read the instructions.

Before performing maintenance operations for the machine, place it on the ground and consult the instruction manual.



Danger of amputation of the arms. Never remove the guards and do not approach to moving parts.



Danger of hooking with PTO drive shaft.

It is strictly forbidden to approach the PTO drive shaft while moving.



Danger of falling.

It is strictly forbidden to ride on the machine



Danger of amputations of the legs.

Keep a safe distance from the machine while it is working.



DANGER! Possibility of material or/and objects release; do not stand nor approach close to the machine. Maintain the min. safe distance described on the label of the machine



WARNING! Ensure the rotation and direction speed (540 RPM or 1000RPM) from the PTO of the tractor before connecting the drive shaft.



Anti-noise personal protection devices. Attachment point for lifting the machine.

SAFETY AND ACCIDENT PREVENTING RULES

- Carefully read this manual before start-up, use, maintenance or other interventions on the machine.
- Pay attention, in addition to the warnings included in this manual, all security and accident prevention rules in general.
- The manual must be always at hand, to be able to consult and check the operational cycle of the machine and information about safety. If it is lost or damaged, you must request a replacement copy.



WARNING

Any maintenance, adjustment or cleaning should be done with the machine in stability conditions, the tractor engine off, the PTO disconnected, the hand brake tightened, the ignition key removed from the starting box.

Carefully read safety stickers placed on the machine and follow the instructions. If damaged or illegible safety stickers, clean or replace them in the exact position, as described in safety indicators section.

WARNING! VERY IMPORTANT

During the period of use, maintenance, repair, manipulation or storage of the machine, the operator must wear safety shoes and gloves.

If needed, must wear anti-noise headphones, dust mask and protection goggles.

Avoid clothes with ruffles, scarves, necklaces and neckties because they might get caught in rotating parts and moving components.



The machine is designed to be used for only one operator, user must always remain on the tractor

Never work with this machine if you are tired, sick or under the influence of alcohol, drugs or medicines.

DANGER!

It is forbidden to climb the machine or transport it, when it is in motion.

Do not, for any reason, enter between the machine and the tractor.



Keep the machine clean of foreign materials than can damage the operation or cause damage to the operator. Some residues as fertilizers are quite corrosive. It is important that no particles remain in the machine during long periods of time. Clean corrosive materials off machine as soon as possible after contact with it .

For air or pressured water used to clean machine, use protection masks and goggles and alert any people or animals near the machine.

Before connecting the machine to the tractor, make sure that the tractor is in good conditions and the brakes work properly, especially when working on sloping land.

Disconnect the machine from the tractor only on compact and horizontal ground, ensuring that is stopped and stable.

WARNING!

The manufacturer is not liable for any damaged caused from unpredictable or improper uses.

**The manufacturer is considered free of any liabilities in case of:**

Improper use of the machine, use by untrained personnel; Serious shortfalls in planned maintenance; Unauthorized modifications or interventions; Use of non-original or specific replacement parts; Total or partial failure of the instructions; Disregard of common safety rules in the field of work.

CONNECTING THE MACHINE TO THE TRACTOR

Ensure the drive shaft is connected properly after each connecting operation of the machine and ensure that is not releasing when you low the machine to start the work.

**WARNING! DANGER!**

Ensure that PTO drive shaft protections are complete and in good conditions.

In case of breakage or damage of the drive shaft protections, replace them immediately.

When the machine is not connected to the power unit, the drive shaft must be placed in the appropriate support.

The presence of the machine can influence the maneuverability of the tractor, especially during transport.

**DANGER!**

Do not, for any reason, stand between the tractor and the machine with the engine running and the power outlet connected.

MACHINE OPERATION

Check the machine before each launch. Start work only if the machine is in perfect conditions.

Before using the machine, make sure that all security devices are located properly in place and in good conditions; if damage or failure in the protections is found, replace them immediately.



DANGER!

During the work, ensure there are no people or animals in the described range on the label.

When working in public places, is ABSOLUTELY MANDATORY to clear people away and increase caution.



WARNING!

Whoever approaches to the machine is in a danger zone and thus becomes an "EXPOSED PERSON".

The operator has to prevent everybody from entering the danger zone and operate the machine with utmost caution. If somebody comes close, the operator must stop the tractor engine immediately.

The machine should not be left unattended when in motion.

Always keep the machine in good working conditions and make maintenance regularly.

SECTION 3: TRANSPORT AND HANDLING



CAUTION!

If the machine, hitched to the tractor, must circulate on the public roads, you must comply with the Highway Code regulations in force in the country in which the machine itself is used.

Along with respect for the rules, when running on public roads, particular attention must be given to the choice of an appropriate speed rate, especially if the road is declining.

In case that the machine hides, the rear signal lights of the tow vehicle, use a repetitive rear display panel. Entering the road after work, you must pay attention to cleaning of tires and working parts, to avoid littering the road with dirt or other materials.



WARNING!

During road use, the flashing orange/yellow device mounted on the tractor must be always on, even during daytime.



WARNING!

During transportation, with the machine raised, ensure that the front elevator control is blocked, to prevent accidental lowering of the machine.

The machine must be raised at least 40cm from the ground for road transport.

If the machine must be transported over a long distance, it can be loaded on a truck.. In this case, consult «Machine dimensions» for the weight and dimensions. This will allow you to make sure that the machine can pass without difficulty.

To lift the machine from the ground to the loading platform, hook up the machine from the relative lifting points indicated on the machine.

Loading with a crane: make sure that the carrying capacity of the crane is fit to lift the weight of the machine. The hitching points for lifting are clearly visible and are marked by stickers. In case you do not have stickers in your machine, you must load it with the associated pallet. *Lift* the machine with the utmost care and move it slowly without jolting on to the truck or railway car.

DANGER! When lifting or transporting, use the greatest care: have all persons not directly involved in the lifting



operations move well clear of the lifting area. Clear the zone to which the machine is to be transferred. Make sure that the available lifting means are fit for the purpose. Do not touch hanging loads and always keep at a safety distance from them. When transported, the loads must not be lifted more than 20 cm from the ground. Make sure that the zone in which the operations take place has a sufficient «escape route», i.e. a clear and safe zone to which the operators can quickly move if the load should fall.

Once the machine has been moved on to the truck or wagon, make sure that it remains blocked in position. Fix the machine firmly to the surface on which it rests by means of the pre-engineered points marked with the «hook» decal, using well tightened ropes or chains suited to its weight and able to prevent it from moving in anyway.

After having transported the machine to the desired site and before removing the elements that hold it in place, make sure that its position is unable to be of danger.

Now remove the ropes and unload the machine from the means of transport in the same way as it was loaded



CAUTION!

The surface on to which the machine is to be loaded must be perfectly horizontal, to prevent the load from shifting.

4 SECTION: INSTRUCTIONS FOR USE



WARNING!

Before setting the machine at work, the operator must have read and understood all parts of this manual and particularly "Section 2" about safety.

Before beginning work, make sure that the machine is in order, and that the lubricating oils are at the right level and that all parts subject to wear and deterioration are fully efficient.

Make sure that the guards are correctly positioned.



WARNING! DANGER!

Adjustments and operations required to prepare the machine for work, must always be carried out with the machine off and blocked.

DRIVELINE



The driveline is a mechanical component. When it is operating it can be a source of danger to the physical well-being of those who work with it. Take the greatest care when carrying out operations that involve the driveline. Carefully read the instruction manual supplied with the driveline.

If you have doubts about the way it operates, if it is without its shields, or broken, replace it with a new driveline that possesses the same characteristics and bears the «CE» mark.

DANGER! Never modify or adapt the driveline in any way.

If the length must be adapted, work with the utmost care so as to keep the telescopic tubes coupled to the maximum extent, With the exception of length adaptation, it is forbidden to modify the driveline; If this is necessary, contact the Manufacturer. Take the greatest care when inserting the driveline. Make sure that it is well locked on both the tractor's PTO and on the machine and comply with the indications in the instruction manual supplied with each driveline. Make sure that the driveline shield, fastened with the relative chains, is free to turn without obstruction. Also check the guards on both the tractor and implement. If they are not in a perfect condition, they must be immediately replaced. It is very important for the protective guards to overlap the driveline shields by at least 5cm on both sides.

Disengage the PTO when the driveline is at an excessively wide angle (never more than 15° - Fig.3) and when is not used.

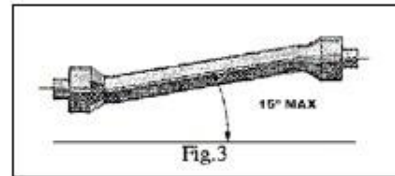
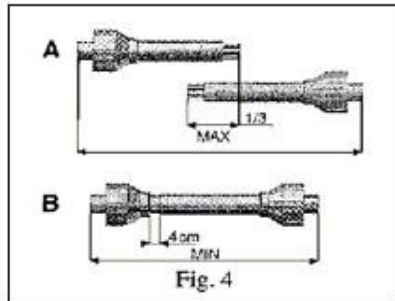

CAUTION!

Before engaging the PTO, make sure that its rotation speed corresponds to the rate for which the machine has been designed (540 rpm).

TO SHORTEN THE DRIVE SHAFT

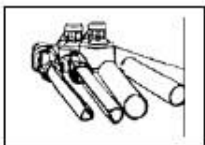

Remove guard.

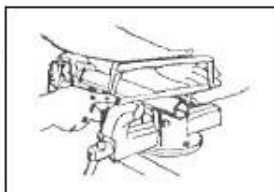

Cut Transmission Tubes at desired Length.

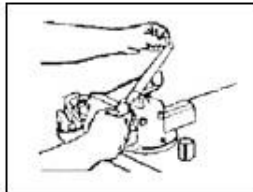

Polish edges of tubes

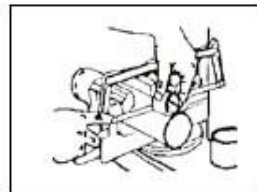

Cut guard tubes at the same length as Transmission tubes

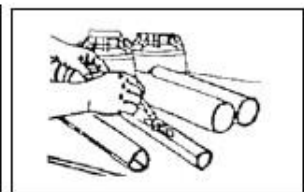

Grease the Transmission tube and mount guard.

ASSEMBLY AND REMOVAL OF THE GUARD

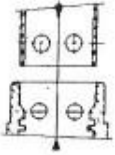

Place the tube in accordance with the pins inside the icon, and enter by pressing and soft strokes to the tube.

Clean and lubricate the collar-housing slot.

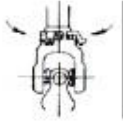
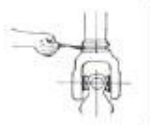

Hold the transmission in vertical position and introduce it in the slot. You can observe it turns perfectly.

Cone lodging must be positioned with the fins of the collar. Press vertically and make sure that fins are introduced in the cone lodging giving a few light strokes on the cone to verify that is in perfect conditions.

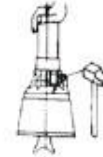

Hold the transmission in a vertical position.

Press the cone down and release the locking collar fins with a screwdriver, pressing inward through the collar fin slot.

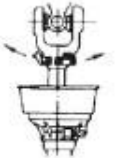
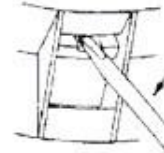

Remove transmission cone-tube assembly and remove the collar from its housing.

WORK POSITION

DANGER! The operator must be seated in the driving seat of the tractor when the machine is working.

Before he leaves the driving seat, the operator must stop the machine, apply the parking brake and turn off the tractor engine.



HITCHING TO THE TRACTOR

DANGER! Hitching to the tractor could be a dangerous operation. Take great care and strictly comply with the instructions.



Proceed in the following way to hitch the machine to the tractor in the correct way:

- Make sure that you are using a tractor whose configuration suits the machine in question.
- Make sure that there are no objects, bystanders or animals in the immediate vicinity of the machine and that the PTO is disengaged.
- Make sure the machine is in a stable, horizontal position, then back the tractor towards the machine.
- Drive the tractor to the implement with caution and adapt the height of the lift links to the height of the hitching pins.
- Move the power lift bars and fit them on to the hitching pins and lock in place with supplied split pins.
- Switch off the tractor engine.
- Connect the top link and adjust it so that the machine is on the flat.
- Lock the power lift bars with the relative chains and parallel idlers on the tractor. This must be done to prevent the machine from swinging sideways.
- Fit the driveline into the tractor's power take-off and make sure that it is perfectly locked in the correct position. Make sure that the shield is free to turn. Fasten the shield with the relative chain. Remove the support from the driveline (4 Fig. 1).

WORK DEPTH ADJUSTMENT

1. By skids (standard).
2. By Roll Bars, Cage roller or Packer (see options at the beginning). This solution is only valid for certain range of machines (see options at the beginning).
The regulation is performed by bolts position by manual or hydraulic clamping. Optionally, level regulating bar supplied. Raising the roller the depth of work increases and lowering it decreases.

IN WORK

Begin work with the PTO at full rate. Gradually dig the implement into the ground. Do not press the accelerator pedal too much with the PTO engaged. To break up the soil to the required degree, you must consider these factors:

- nature of the soil (medium consistency, sandy, clayey, etc.)
- the work depth
- the ground speed of the tractor
- optimum machine adjustment

Soil crumbling is obtained at a low tractor ground speed, with the rear bar lowered and the blades spinning at the specified rpm in the machine.

HOW TO WORK

Adjust the skid or the roller (8 Fig.1) to suit the degree to which the soil must be crumbled, engage the PTO and begin to move forward with the tractor, progressively lowering the implement. Cover a short distance, then check to make sure that the work depth, soil crumbling and ground leveling operations have been carried out in the required way. The speed of the tractor when the machine is in operation must not exceed 5km/h or components could be broken or damaged. The blades may throw up stones or other sharp objects as they spin. Constantly check to make sure that there are no bystanders, children or domestic animals within the range of action of the machine.

USEFUL ADVICE

DEPTH TOO SHALLOW

Check the depth adjustment.

Move forward more slowly. There may be insufficient tractor power. Raise the rear roller.

Further runs will be required if the soil is too hard.

The blades slide over the ground instead of digging into the soil: advance more slowly.

SOIL CRUMBLED TOO FINELY

Lower the speed of the blade rotors.

Increase the tractor ground speed.

SOIL INSUFFICIENTLY WORKED

Increase the speed of the blade rotors.

Reduce the ground speed.

Do not work if the soil is too wet.

If the leveling bar is installed, try lifting or lowering it.

CLOGGED ROTORS

Soil too wet to work.

Raise the leveling bar.

Reduce the ground speed.

Do not work where the grass is too tall.

THE MACHINE JOLTS OVER THE GROUND OR VIBRATES

Foreign bodies locked between the blades.

Blades incorrectly mounted in the wrong positions.

Worn or broken blades.

Blades bent during work after hitting stones or having worked excessively hard soil.

THE MACHINE VIBRATES TOO MUCH

Reduce the ground speed of the tractor.

Adjust the machine in the correct way, as described in the instructions.

Clean the rotors. They could be clogged.

Check whether any blades are broken. Replace them if this is the case.

THE ROTORS TURN IN AN UNEVEN WAY (just in case of clutch drive shaft option)

Make sure that the driveline clutch is regulated correctly.

Excessively elastic clutch springs. Replace the springs.

THE DRIVELINE CLUTCH OVERHEATS (just in case of clutch drive shaft option)

Check the clutch plates for wear. Have them replaced by an authorized workshop if necessary.

Excessively elastic clutch springs. Replace the springs.

THE GEARBOXES OVERHEAT

Check the oil level and top up if necessary.

TINES

The blades fitted on the implement are suitable for soil of a normal consistency. Check them daily to make sure that they are in a good condition and not worn. If the blades should accidentally bend (or break) during work, they must be immediately replaced. Make sure that the new blades are mounted in exactly the same positions as the old ones. If several blades must be replaced, it is advisable to demount and remount them one at a time in order to avoid positioning errors. The sharp side of the blades must point towards the direction in which the blade rotor turns.



DANGER!

Blade replacement is a dangerous operation.

Proceed in the following way to change the blades:

- Park** the tractor on a flat surface with the machine hitched, and then raise the machine with the power lift.
- Insert** two strong bearing stands at the sides of the machine.
- Lower** the machine on to the stands, turn off the tractor engine and apply the parking brake.
- Make** sure new replacement blades are mounted in the same positions as the old ones.

M8	15	26	36	44
M10	30	52	74	88
M12	51	91	127	153
M14	81	143	201	241
M16	120	214	301	361
M18	173	300	433	520
M20	242	431	606	727
M22	321	571	803	764
M24	411	731	1028	1234



DANGER!

If the tines clog, DO NOT attempt to clean the machine whilst it is operating. Disengage the PTO, stop the tractor and engage the parking brake. Wait until all moving parts have come to a complete standstill, then proceed with the cleaning operations with the utmost care.

STOPPING THE MACHINE

operator disengage the tractor PTO.

Close the machine behind the tractor.

Lower the machine to the ground.

Stop the tractor and engage the parking brake.

Make sure that all parts of the machine have come to a standstill.

Only after the above mentioned operations have been carried out may the operator leave the tractor unattended.

At the end of the job, the

PARKING To park the machine and unhitch it from the tractor, the operator must:

Make sure that no one is standing or crossing the place where the machine will be parked.

Make sure that the place in which the machine is to be parked is suitable, flat and uncluttered.

Drive to the area where the machine is to be unhitched.

Brake the tractor.

Lower the bearing stands.

Completely lower the machine to the ground.

Stop the tractor and engage the parking brake.

With the tractor stopped, its engine off and the components at a complete standstill, operate the levers of the hydraulic circuit so as to relieve the pressure from inside the pipes. This will allow you to re-connect the quick couplings with greater ease.

Disconnect the quick couplings.

Remove the driveline from the tractor's PTO and rest it on its bracket.

Disconnect the top link rod.

Disconnect the power lift links.

Switch on the tractor engine and move away.



WARNING! The place in which the machine is parked must be:

Dry and sheltered from adverse weather condition.

Guarded or locked up to prevent the machine from being accessed by animals, children or persons who are not trained to use it.

SECTION 5: MAINTENANCE

Lower running costs and long machine life depend on continual compliance with these instructions. Before proceeding with any operation, make sure that the machine is parked on a flat surface. Prevent it from moving, by placing chocks under the wheels.

Servicing, adjusting and the operations require the tractor and the driveline to be detached from the machine. The servicing frequencies indicated in this manual are indicative and refer to normal conditions of use. They may vary depending on the type of service, whether the environment is dirty, seasonal factors, etc. The servicing operations must be carried out more frequently in heavier duty service conditions.

Before injecting lubricating grease into the grease nipples, carefully clean the unions to prevent dirt or dust from mixing with the grease as this would reduce or even annul its lubricating effects. Injection into the greasing points of a large quantity of grease at high pressure can damage the bearing protection. Lubricate and grease all the required points. Use oil of the recommended type for topping up and changes. Keep all lubricants well away from children's reach. Read the warnings and precautions on lubricant containers. Thoroughly wash your hands after using lubricants. Dispose of used oil in compliance with the anti-pollution laws.

LUBRICATION

Lubrication of any machine with parts that turn or rub together is a vitally important task for the life and functionality of the machine. Lubrication must be carried out systematically and at the required intervals. The frequencies given refer to machine use in a normal environment. If this machine is used in heavier duty conditions, it must be lubricated more frequently.

It is advisable to lubricate the overdrive and the Gearbox with:
SAE 85W/140 OIL, complying with API-GLS/MIL-L-210SC specifications.

The lateral transmission with 800g lithium Grease

For all greasing points, the Manufacturer recommends: LITHIUM GREASE.

When servicing the driveline, strictly comply with the instructions given by the driveline Manufacturer, in the specific operation and maintenance manual with which each driveline is equipped.

AFTER THE FIRST EIGHT HOURS SERVICE

Each new machine must be checked after the first 8 hours service. Proceed in the following way:

Check the general condition of the machine.

Make sure that all the screws are well tightened.

Check the cutting tools for wear and make sure that the bolts that fasten them are well tightened.

Check the tension of the belts (in case it have it)

Check the level of the lubricants.

Chain tension is done by the tension spring (A Fig 7). In case spring loses strength must be changed and replaced by a new one in the same position.

EVERY 20 HOURS SERVICE

Make sure that the screws that fix the cutting tools are well tightened.

Grease the driveline.

EVERY 100 HOURS SERVICE

Check the level of the oil in the overdrive housing.

If necessary, top it up through the plug on the top of the gearbox.

EVERY 500 HOURS SERVICE

Change the oil in the gearbox after every 500 hours service or at least once a year.

WARNING!

The used oil or grease, must to be thrown in the Green Point or Waste collection to avoid damage to the environment.



PREPARING FOR STORAGE

At the end of the season or if the machine is to remain idle for a long period of time:

Wash all fertilizers and chemical products from the machine and dry it.

Carefully check the machine and replace any damaged or worn parts.

Fully tighten all the screws and bolts, particularly the ones that fix the tines.

Thoroughly grease the machine and then cover it with a tarpaulin and store it in a dry place.

If these operations are carried out, it will be all to the user's advantage, as the machine will be in optimum conditions when needed again. If the machine must be dismantled, comply with the antipollution laws in force. Old lubricants and the various components must be disposed of according to their different structures.

